

Analogic CO₂ Gas Detector



Part Number: NP300CO2GB
Revision: B.0
07/2015→

Copyright © 2016 by *Oldham S.A.S.*

April 2016

All rights reserved. No reproduction of all or part of this document, in any form, is permitted without the written consent of *Oldham S.A.S.*

All information provided in this document is accurate to the best of our knowledge.

As a result of continuous research and development, the specifications of this product may be changed without prior notice.

Oldham S.A.S
Rue Orfila
Z.I. Est – CS 20417
F – 62027 ARRAS Cedex
Tel : +33 (0)3 21 60 80 80
Fax: +33 (0)3 21 60 80 00

Contents

Chapter 1 General Information	5
User Manual	5
Symbols used.....	5
Safety instructions.....	6
Important information	6
Liability limits	7
Chapter 2 Introduction	9
General Information	9
CTX300 CO ₂ versions	10
Composition	10
Chapter 3 Installation and connection	11
Installing the detectors	11
Electrical connections	13
Chapter 4 Powering up and use	17
Powering up	17
4-20 mA analog output.....	17
Chapter 5 Maintenance	18
Calibration	18
Checking the current generator.....	23
Replacing a sensor	24
Disposal.....	24
Chapter 6 Spare parts	25
CTX 300 CO ₂	25
Chapter 7 Certification	27

Chapter 8 Technical specifications29

Chapter 9 | Annex31

CTX 300 overview31

Chapter 1 | General Information



User Manual

The instructions given in this manual must be read thoroughly before installation and start-up, particularly those concerning the points related to the safety of the end-user. This user manual must be made available to every person involved in the activation, use, maintenance, and repair of the unit. The information, technical data, and diagrams contained in this manual are based on the information that is available at a given time. In case of doubt, contact *Oldham* for additional information.

The aim of this manual is to supply simple and accurate information to the user. *Oldham* cannot be held liable for any misinterpretations in the reading of this manual. In spite of our efforts to produce an error-free manual, it may nonetheless contain some unintentional technical inaccuracies.

In the client's interest, *Oldham* reserves the right to modify the technical characteristics of its equipment to increase their performance without prior notice. The present instructions and their content are the inalienable property of *Oldham*.

Symbols used

Icon	Significance
	This symbol indicates useful additional information.
	This symbol indicates: This equipment must be connected to ground.
	This symbol indicates: Protective earth terminal. A cable of the adequate diameter must be connected to ground and to the terminal having this symbol.



This symbol indicates:
You must refer to the instructions.



This symbol indicates:
Warning! In the present mode of use, failure to adhere to the instructions preceded by this symbol can result in a risk of electric shock and/or death.



European Union (and EEA) only. This symbol indicates that this product must not be discarded with household waste, as per the EEA directive (2002/96/EC) and your own national regulations.

This product must be disposed of at a collection point that is reserved for this purpose, for example, an official site for the collection of electrical and electronic equipment (EEE) in view of their recycling, or a point of exchange for authorized products that is accessible when you acquire a new product of the same type.

Any deviation as regards these recommendations for the disposal of this type of waste can have negative effects on the environment and public health, as these electric and electronic products generally contain substances that can be dangerous. Your full cooperation in the proper disposal of this product promotes a better use of natural resources.

Safety instructions

Labels intended to remind you of the principal precautions of use have been placed on the unit in the form of pictograms. These labels are considered an integral part of the unit. If a label falls off or becomes illegible, please ensure it is replaced. The significance of the labels is detailed below.



The installation and electrical connections must be carried out by qualified personnel according to the instructions of the manufacturer and the standards of the competent authorities.

Failure to adhere to the instructions can have serious consequences on the safety of persons. Please be extremely rigorous as regards electricity and assembly (coupling, network connections).

Important information

The modification of the material and the use of parts of an unspecified origin shall entail the cancellation of any form of warranty.

The use of the unit has been projected for the applications specified in the technical characteristics. Exceeding the indicated values cannot in any case be authorized.

Liability limits

Neither *Oldham* nor any other associated company under any circumstances can be held liable for any damage, including, without limitations, damages for loss or interruption of manufacture, loss of information, defect of the *MX 43* control unit, injuries, loss of time, financial or material loss, or any direct or indirect consequence of loss occurring in the context of the use or impossibility of use of the product, even in the event that *Oldham* has been informed of such damage.

Chapter 2 | Introduction

General Information

CTX300 CO₂ gas detectors are designed to measure carbon dioxide. With robust materials, a specifically-adapted design, appropriate accessories, stainless bolts and a polyamide case (IP54), CTX 300 detectors are designed to withstand the roughest conditions.



Figure 1: overview of a CTX 300 with display (left) and without display (right).

CTX300 CO₂ versions



In the case of a CTX 300 for the CO₂ detection, this manual can only be used for devices delivered since July 2015.



P/N : 6514879
P/N : 6514880
P/N : 6514881
P/N : 6514882

Figure 2: CTX 300 CO₂ detector delivered before July 2015



P/N : 6314124

Figure 3: CTX 300 CO₂ detector delivered since July 2015

Composition

Sensor type	CTX 300
Gases detected	CO ₂ .
Detection method	Infrared absorption.
Type of sensor pack	Pre-calibrated removable sensor pack (1).
Options	With display.
Certification	None

(1) Choice between several scales.

Chapter 3 | Installation and connection

Installing the detectors

Layout

While the measuring sensor is always located on the underside of the detector, several factors determine where the detector should be located:

- If the gas being measured is lighter than the air, place the detector near the ceiling.
- If the gas is heavier than the air (CO₂ and Freons, for example) place the detector close to the floor.
- Near offtake points.
- Generally, in locations where gas may accumulate, taking into consideration both:
 - The effects of temperature;
 - The outside winds direction.

Determining the best sensor location

Factors to consider when determining the best placement for the detector are:

- Potential sources for vapor and gas emissions.
- Characteristics of gases and vapors (density).
- Air circulation:
 - Inside: mechanical or natural ventilation.
 - Outside: wind direction and velocity.
- Effects of temperature.
- Local constraints (air flow, water splash, etc.).

Detectors should always be located in an easily accessible location for maintenance purposes.

Special accessories may be necessary to protect the equipment against any liquid projectiles, dust, direct sunlight or low temperatures in the area.

Mechanical installation

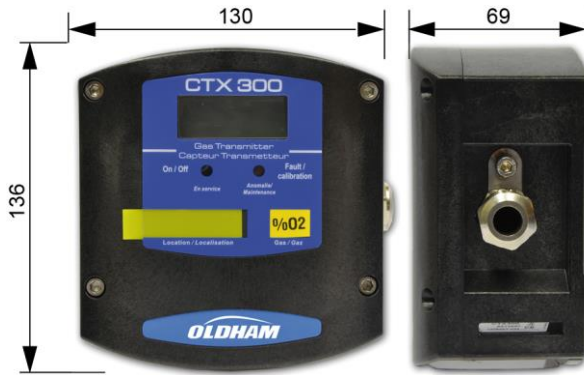

Figure 4: overall dimensions of the CTX 300.

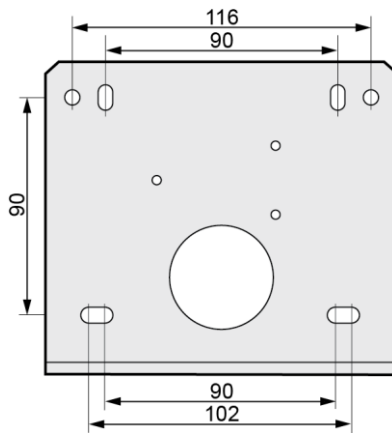

Figure 5: drilling diagram for wall mounting (view of the side flattened onto the ceiling).

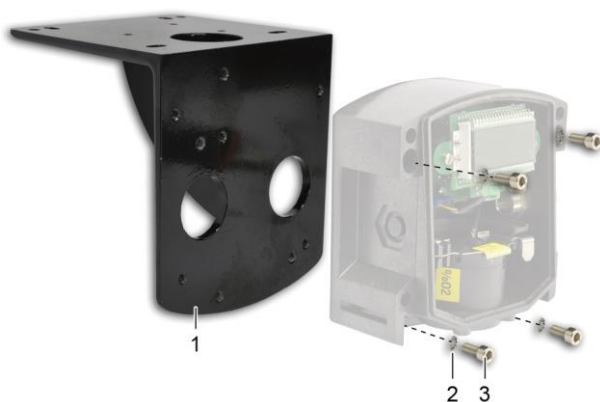

Figure 6: ceiling mounting with a brace. The fixing drawing is identical to this of the wall mount.

Ref.	Qty	Description	Code	Material
1	1	Brace	6132380	Stainless
2	4	Washer A25 ACCD	6905518	Stainless
3	4	Screw CHC LI2	6902218	Stainless

Electrical connections

Wiring specifications

If needed, consult the grounding instructions for *Oldham* instruments and related connection materials in Annex 1.

Connections for the various types of sensors

Wire	CTX 300 CO ₂ with display	CTX 300 CO ₂ without display
Output signal	4-20 mA	4-20 mA
Active wires	3	3
Cable entry	1 x 6-11 mm	1 x 6-11 mm

Connection of a 3-wire sensor to an Oldham control unit

Wire	Terminal number
(+) V DC power supply:	3
(-) V DC power supply (masse 0 V):	2
Output signal:	1

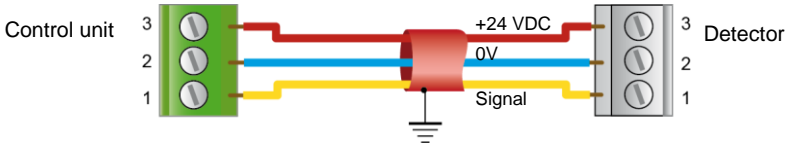

Figure 7: connection of a 3-wire sensor to an Oldham control unit.

Connection of a 3-wire CTX300 sensor to a non-OLDHAM control unit with an internal power supply

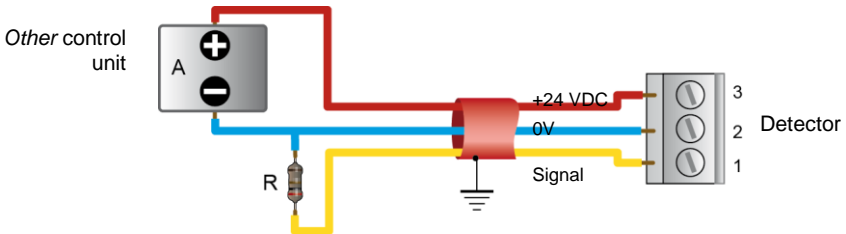

Figure 8: Connection of a 3-wire CTX300 sensor to a non-OLDHAM control unit.

- (R) Maximal load = 200 Ω .
- (A) Power supply $15 \leq V_{cc} \leq 32$.
 $18 \leq V_{cc} \leq 30$ for CO₂ sensor.
 $I_{max} = 100$ mA.

Operating mode

CTX300 with display

- Remove the 4 screws (ref. 1).
- Remove the cover (ref. 2).



Figure 9

- Completely remove the screw (ref. 4).
- Unscrew the screw a few turns (ref. 3).



Figure 10

- Turn the display circuit as shown (ref. 5).
- Connect the cable (ref. 6) to the connector. Refer to paragraph *Connections for the various types of sensors* on page 13.
- Return the display circuit to its original position and replace the cover.



Figure 11

CTX 300 without display

- Unscrew the 4 screws (ref. 1).
- Remove the cover (rep. 2).
- Proceed to wire the sensor according to the terminal location.



Figure 12

Chapter 4 | Powering up and use

Powering up

- The sensor turns on when connected to a power supply.
- If the sensor has a display, the green LED will be lit (ref. 2) and a value will appear on the display screen (ref. 1).



Figure 13

4-20 mA analog output

For CTX 300 sensors, the 4-20 mA output current is proportional to the gas level.

Notes:

The various states of the 4-20 mA output are:

- 1.5 mA to indicate an electronic fault.
- 1.8 mA to indicate an absence of sensor.
- Between 4 and 20 mA for measurement values.
- ≥ 20 mA if levels exceed measurement range.

Chapter 5 | Maintenance



The adjustment operations in this paragraph are reserved for authorized, trained personnel because they may compromise detection reliability.

Gas detectors are safety devices. OLDHAM recommends the regular testing of fixed gas detection installations. This type of test consists of injecting the calibration gas into the detector at a sufficient concentration to activate the pre-set alarms. It is to be understood that this test is in no way a replacement for a detector calibration.

The frequency of gas tests depends on the industrial application where the detector is in use. Frequent inspections should be made in the months following the commissioning of the installation, and should then become more widely spaced provided that no significant deviation is observed. If a detector should fail to react in contact with the gas, calibration is essential. The frequency of calibrations shall be appropriate according to the results of the tests (humidity, temperature, dust, etc.); however, it must not exceed one year.

The general manager should put safety procedures in place on-site. OLDHAM cannot be held responsible for their enforcement.

Calibration Recommendations

Calibration consists of adjusting the zero of the clean air sensor and adjusting sensitivity with a test gas. Adjustments are made at the sensor level.

Equipment needed to calibrate the detector correctly:

- Flexible plastic tubing (Figure 14, ref. 2).
- Manometer and regulator valve for the compressed gas cylinders (rep. 3).
- 0 to 60 l/h flow meter (if the cylinder is not equipped with one).
- Calibration pipe (ref. 1), which may vary depending on the nature of the gas (see pages 25 and following).
- Test gas cylinder (ref. 4).



Figure 14: sensor calibration assembly.

Zero adjustment should be performed in a gas and vapor free area. If this is not possible, synthetic bottled air can be injected at a rate of 60 l/h.

Use a bottle of test gas to adjust sensor sensitivity (concentration close to the alarm threshold or corresponding to 30% of the measurement range at a minimum). The recommended rate is 60 l/h.

Note: when dealing with dangerous gases, you **MUST** consult a specialized *Oldham* technician or use another sensor pack recently pre-calibrated at a factory.



The detector should be calibrated using the intended flow-rate. The actual concentration of gas may be underestimated if the detector was calibrated with too high of a flow rate.

CTX 300 calibration

1st case: CTX 300 with display

- The sensor is operating: the green light (ref. 1) is lit and the display screen shows the measurement level.

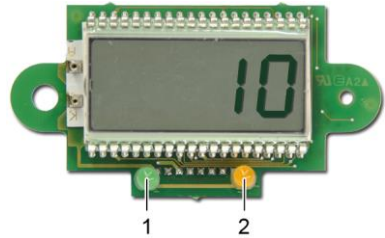

Figure 15

- Verify that the sensor is located in a clean-air environment. If not, inject synthetic air at a flow rate of 60 l/h.
- Wait for the measurement to stabilize (displayed on screen) and adjust the zero by using the ZERO potentiometer located on the sensor pack (ref. 2).
- Inject the recommended calibration gas at a flow rate of 60 l/h.
- Wait for the measurement to stabilize.
- Adjust the sensitivity by using the sensitivity potentiometer located on the sensor pack (rep. 1).
- Stop injecting the calibration gas.
- Remove the gas injection pipe, then wait and verify that the signal returns to zero. Repeat procedure if it does not.
- Calibration is complete.



Figure 16

2nd case: CTX 300 without display

- The sensor is operating.
- Verify that the sensor is located in a clean-air environment. Use the calibration kit and follow all recommendations.
- Connect a voltmeter to the AF+ and AF- terminals (caliber mV/DC).

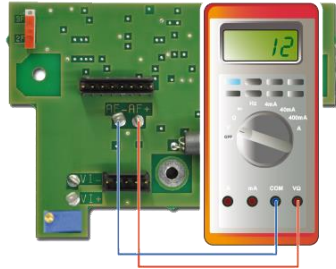

Figure 17

- Wait for the signal to stabilize and adjust the zero by using the ZERO potentiometer located on the sensor pack (Figure 18, ref. 2). The output signal should be 0 mV.
- Now inject the recommended test gas at a flow rate of 60 l/h. Use the calibration kit and follow all recommendations.
- Wait until the signal has stabilized.
- Read the mV value on the voltmeter (Figure 17), with the full scale at 1600 mV. Calculate the value to be read as a function of your test gas.



Figure 18

- Adjust the displayed value using the potentiometer (Figure 18, rep.1).

Example

- *CO₂ sensor.*
 - *Scale 0-5000 ppm.*
 - *Standard gas concentration: 3000 ppm.*
 - *Reading: 1360 mV.*
- Shut off the calibration gas injection.
 - Withdraw the gas injection pipe.
 - Then wait and check that the scale has returned to zero. Otherwise, repeat the entire procedure.

Checking the current generator

Although this setting is made in the factory, it is possible that the transmitter and controller may have to be matched. In this case, proceed as follows:

- Connect a voltmeter to the AF+ and AF- terminals (caliber mV/DC) (Figure 19).
- Verify that the sensor is located in a clean-air environment. If not, inject synthetic air at a flow rate of 60 l/h.

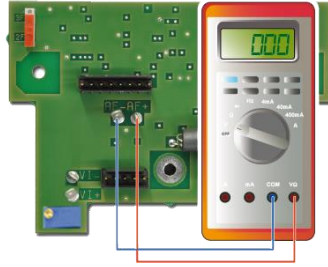

Figure 19

112

- Wait for the measurement to stabilize (displayed on screen) and adjust the zero by using the ZERO potentiometer located on the sensor pack (Figure 20, ref. 2).



Figure 20

034

- The instrument then sends a 4 mA signal down the line. Connect a voltmeter to the VI+ and VI- terminals (caliber mV/DC). The multimeter displays 400 mV
- If some different value is displayed, adjust P1 (Figure 21, rep. 1).
- adjustment is complete.

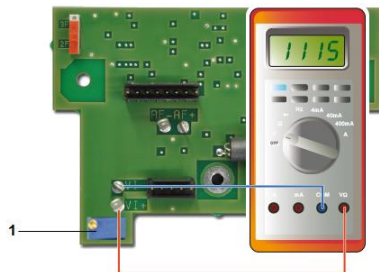

Figure 21

114

Replacing a sensor

Sensors must be replaced:

- When calibration is no longer possible (no sensitivity);
- During preventative maintenance.

The replacement sensor should be identical to the original sensor (same gas, same range). After a sensor has been replaced, a calibration or test (for pre-calibrated sensors) must be conducted.

Disposal



For the preservation, protection and improvement of environmental quality, and for the protection of human health and the prudent and rational utilization of natural resources, the *CTX 300* must be disposed of separately from electronic equipment and cannot be disposed of with normal household waste. The user therefore has an obligation to separate the *CTX 300* sensor from other waste to ensure that it is recycled safely for the environment. For further details on existing collection sites, contact the local administration or seller of the product.

Chapter 6 | Spare parts

List of spare parts for different detectors.



Replacement parts must imperatively be guaranteed origin *Oldham*. Otherwise, material safety could be jeopardized.

CTX 300 CO₂

P/N	Description	Picture
6147868	CTX 300 tool kit.	
6322420	Mounting brace and bolts (CTX 300) ceiling mount.	
6323607	Gas collector (s).	
6331137	Gas introduction device for O ₂ , CO, H ₂ S, NO, H ₂ .	
6331141	Gas introduction device for explosible gases and other toxic gases.	

P/N	Description	Picture
6327906	Device for remote gas introduction.	
6335953	Replacement filter. PTFE protector filter.	
<i>Pre-calibrated CO₂ sensor pack</i>		
6314193	CTX 300 CO ₂ - 5000 ppm / 0.50% vol. sensor pack.	
6314191	CTX 300 CO ₂ – 5% vol. sensor pack.	
6314192	CTX 300 CO ₂ – 100% vol. sensor pack.	
<i>Replacement parts</i>		
6323608	Cover without display.	
6323609	Cover with display.	
6815919	CTX 300 without display label.	
6815921	CTX 300 wit display label.	
6451466	Display card.	
6815923	<i>Localization</i> sticker.	
6451644	Motherboard.	

Chapter 7 | Certification

The following page reproduces the EU declaration of conformity.



DECLARATION UE DE CONFORMITE
EU Declaration of Conformity



La société **Oldham S.A.S.**, ZI Est 62000 Arras France, atteste que la
Oldham S.A.S. company, ZI Est 62000 Arras France, declares that the

Détecteurs de gaz CTX 300 CO₂
CTX 300 CO₂ Gas Detectors

sont conformes aux exigences des Directives Européennes suivantes :
comply with the requirements of the following European Directives:

I) Directive Européenne CEM 2014/30/UE du 26/02/14: Compatibilité Electromagnétique
The European Directive EMC 2014/30/UE dated from 26/02/14: Electromagnetic Compatibility

Normes harmonisées appliquées: **EN 50270:06** for types 1&2 CEM-Appareils de détection de gaz
Harmonised applied Standards EMC-Apparatus for the detection of gases

Arras, le 20/04/2016 (April 20th, 2016)

Michel Spellemaeker
Global Director of Product Management



Oldham S.A.S.
Z.I. EST - CS 20417
62027 ARRAS Cedex - FRANCE
Tel. : +33(0)3 21 60 80 80
www.oldhamgas.com

Chapter 8 Technical specifications

Enclosure.	Polycarbonate housing.
Function.	Detector-transmitter
Display	Highly visible backlight display unit (optional, gas dependent)
Indicator lights	In operation: green color (on CTX 300 : 3-wire) Failure / maintenance: yellow color
Link	2 wires, shielded LiYCY type – CTX 300 without display unit 3 wires, shielded LiYCY type – CTX 300 with display unit
Cable entry	PG9 cable gland (outer diameter 6 to 11 mm)
Power supply	15 to 32 V DC
Power consumption	CTX 300 without display unit: 60 mA CTX 300 with display unit: 100 mA
Operating temperature	-20°C to +50°C, -4 to + 122°F with display -40°C to + 50°C, -40°F to + 122°F without display
Sealing	IP 54, NEMA 3 & 3R
Weight	520 g
Dimensions	130 x 136 x 69 (l x h x d) in mm ; (5.12" x 5.35" x 2.72")
EMC	Type 1 & 2 according to EN 50270:06
Impedance	32 ohms max loop for CTX 300 with display unit 64 ohms max loop for CTX 300 without display unit

Gas	Type of sensor	Range (ppm)	Operating temperature	Relative humidity uncondensed	Accuracy (at PA full scale)	Life span (in month)	T(50) (seconds)
CO ₂	IR	0.50%	-40°C to +50°C	0% to 95% RH	+/-2%	60	<20
		5.00%	-40°C to +50°C	0% to 95% RH	+/-2%	60	<20
		100%	-40°C to +50°C	0% to 95% RH	+/-2%	60	<20

IR : Infrared

Chapter 9 | Annex

CTX 300 overview

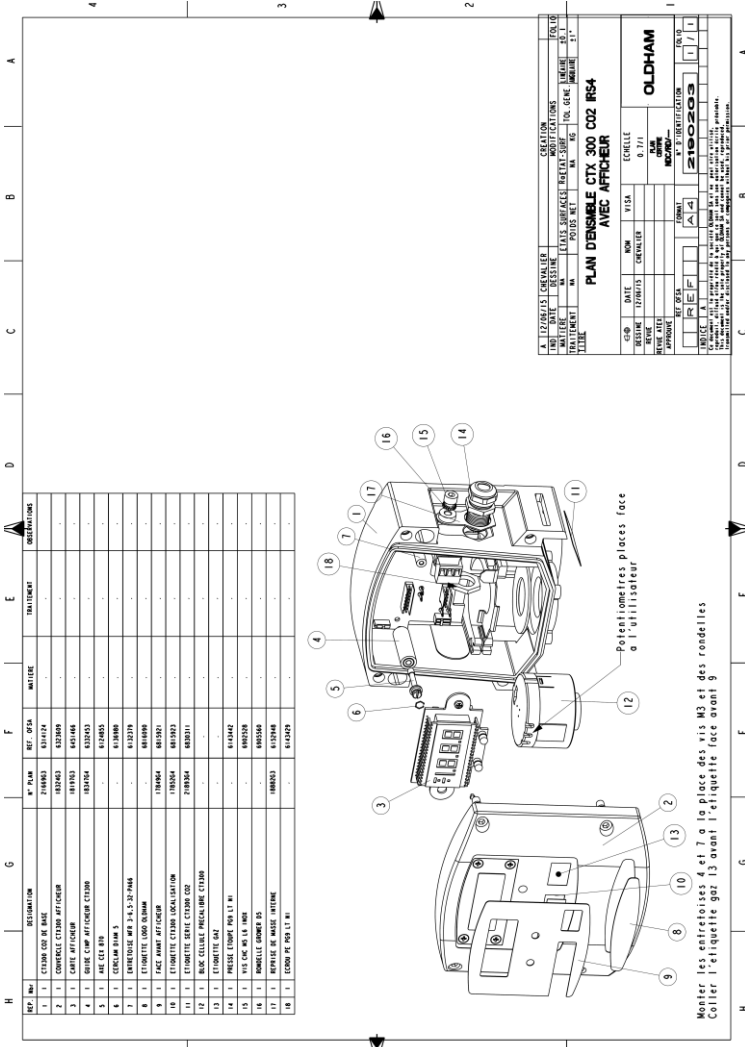

Figure 22: CTX 300 with sensor pack and display – overview.

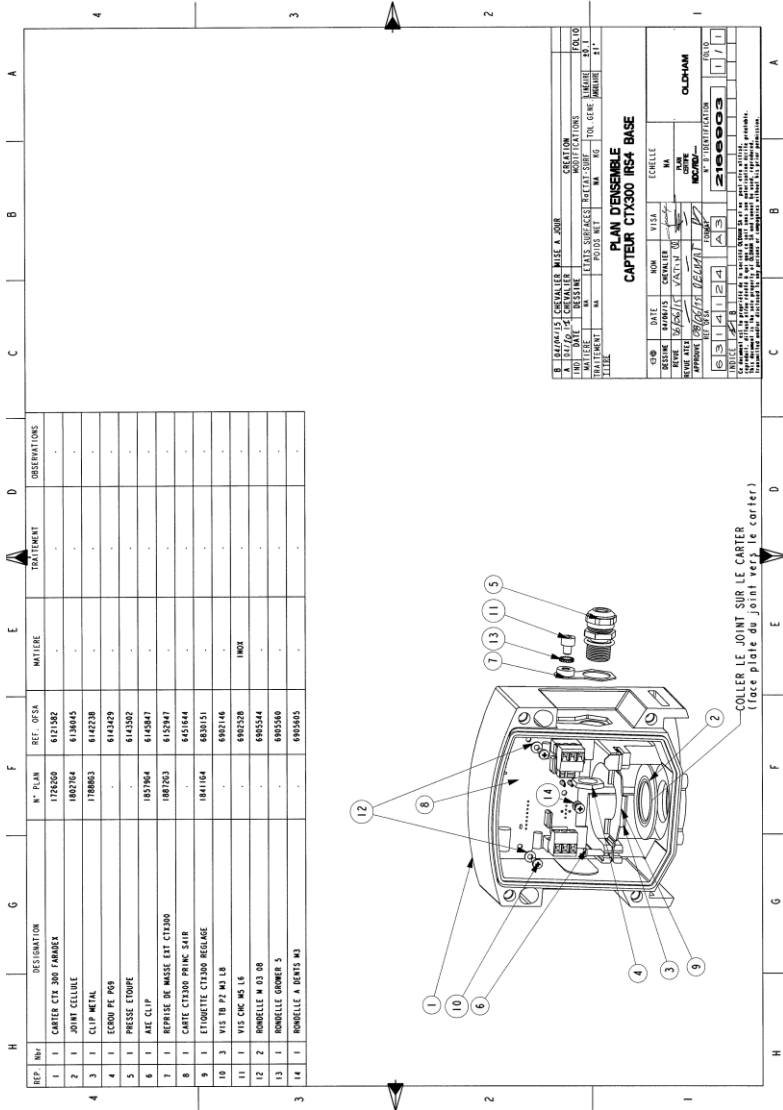

Figure 23: CTX 300 – overview.



EUROPEAN PLANT AND OFFICES

Z.I. Est – rue Orfila CS 20417 – 62027 Arras Cedex FRANCE

Tél: +33 (0)3 21 60 80 80 – Fax: +33 (0)3 21 60 80 00

Website: <http://www.oldhamgas.com>

AMERICAS

Tel: +1 713-559-9280

Fax: +1 281-292-2860

americas@oldhamgas.com

ASIA PACIFIC

Tel: +86-21-3127-6373

Fax: +86-21-3127-6365

sales@oldhamgas.com

EUROPE

Tel: +33-321-608-080

Fax: +33-321-608-000

info@oldhamgas.com